

Article number: 12857000030820  
Description: KLEE-coil 857 000 030.820  
M3 Brass

## Measures

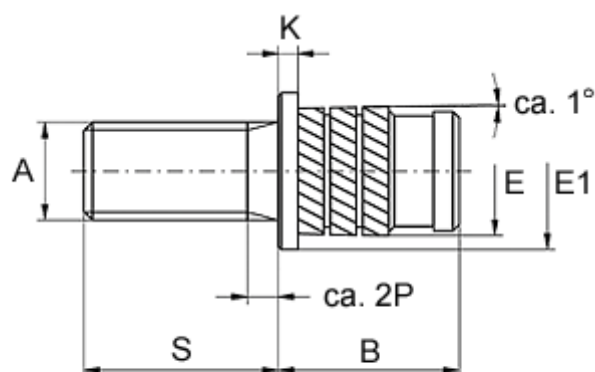

Gevindlængde =  $S - 2P$   
P = stigning

Flange diameter E1	= 5.6
Flange height	= 0.6
Male thread A	= M3x0,5
Min distance to edge	= 2.0
Mounting length B	= 5.3
Outer diameter E	= 4.20
Pin length S	= 6
Recommended bore diameter	= 3.8